

HD 3.1 / 31 P

English 2

Español 14

Français 26

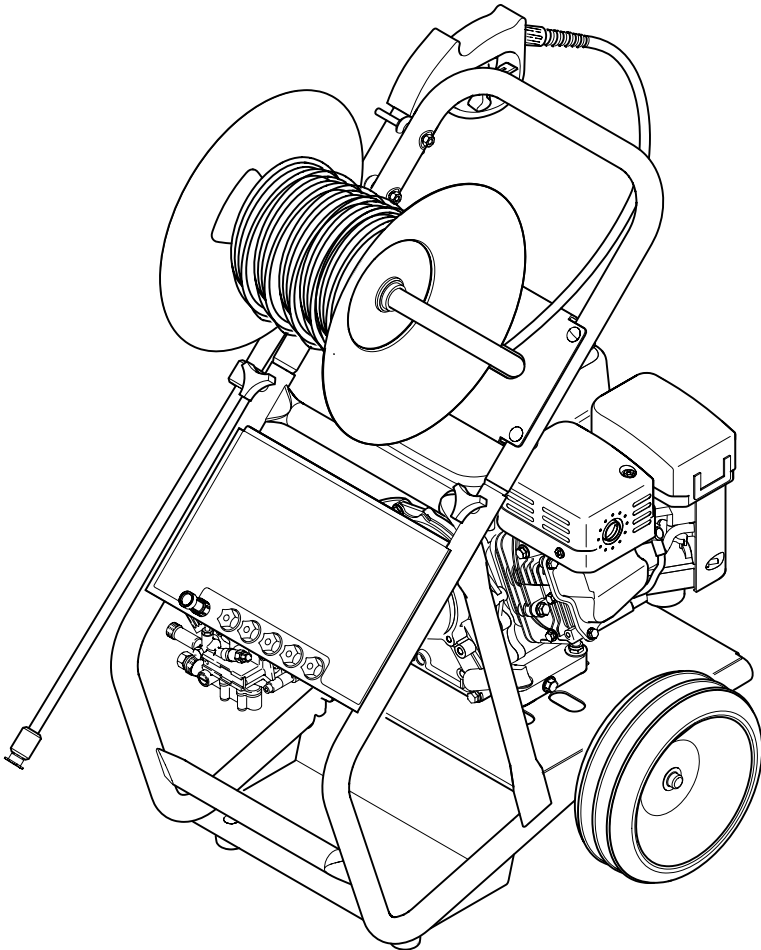

High Pressure Washer Operator Manual

Overview	3
Precautions	4
Assembly Instructions	5
Operating Instructions	6
Using the Accessories	7
Working with Detergents	8
Shut Down and Clean-Up	9
Taking a Break.....	9
Winterizing and Long-Term Storage	9
Cleaning Tips	10-11
Optional Cleaning Accessories	11
Troubleshooting	12-13

2

Specifications

Max. Pressure	3100 PSI
Water volume	3.1 GPM
Detergent suction	0.15 – 0.20 GPM
Engine	9.0 HP Honda GX 270
Part No.	1.575-107
Serial No.	_____

Kärcher Commercial USA

To locate a dealer, call:

1-888-805-9852

or visit our website:

www.karchercommercial.us

Model HD 3.1 / 31 P OVERVIEW

Item Description

- | | |
|--|-----------------------------------|
| 1 Handle | 9 High pressure outlet |
| 2 Trigger gun | 10 Detergent filter |
| 3 Trigger gun safety lock | 11 Detergent suction tube |
| 4 High pressure hose | 12 Spark plug |
| 5 Gas tank | 13 Hose Reel |
| 6 Spray wand | 14 Quick connect nozzles |
| 7 Dipstick | 15 Oil fill cap (pump) |
| 8 Water inlet with garden hose connector | 16 Drain plug / washer (for pump) |

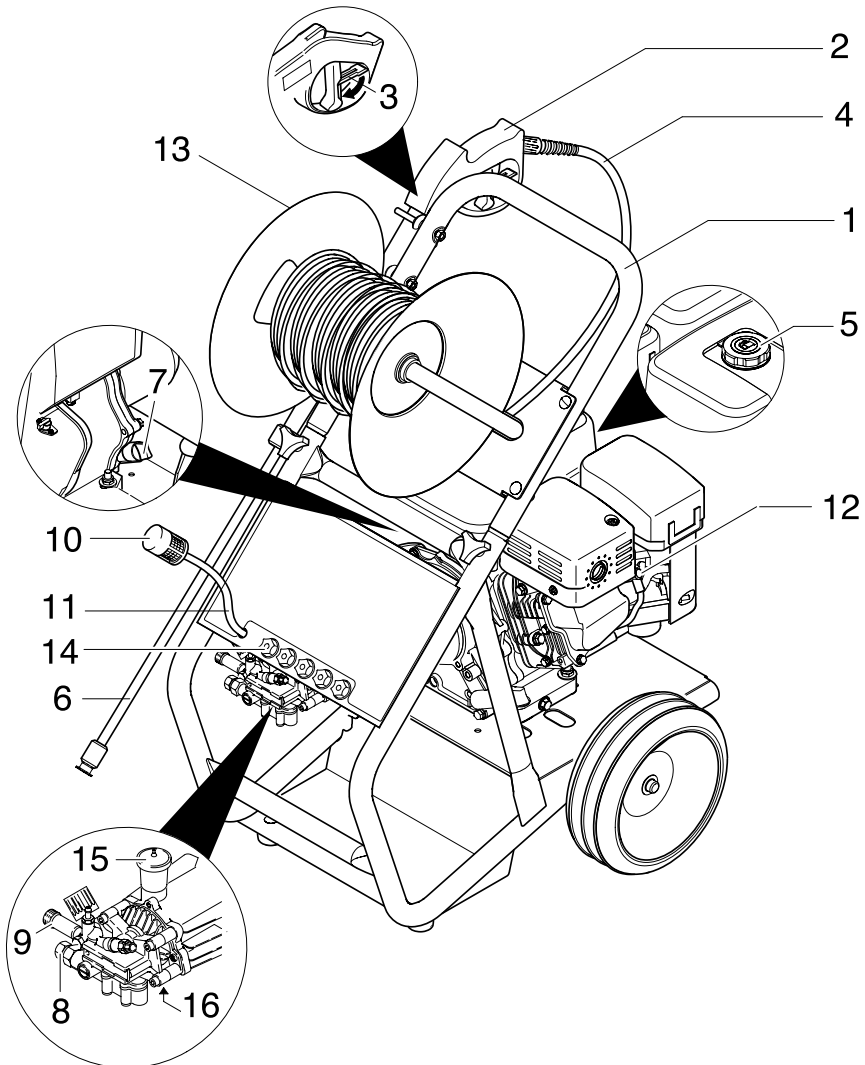

IMPORTANT PRECAUTIONS – Read First!

IMPORTANT SAFETY INSTRUCTIONS

WARNING – When using this product basic precautions should always be followed, including the following:

WARNING – Risk of Injection or Injury – Do Not Direct Discharge Stream At Persons.

- Read all the instructions before using the product.
- Fire hazard! Do not add fuel with the engine running. Do not operate if fuel has been spilled. Instead, move the machine to a different location and avoid creating sparks.
- Operate and fuel machine in a well ventilated area, free of devices featuring an open pilot or flame such as boilers, water heaters, etc.
- High pressure jets can be dangerous if subject to misuse. The jet must not be directed at persons, animals, electrical devices, or the machine itself.
- 4 • Wear safety goggles.
- Do not use acids, alkaline, solvents, or any flammable material in this product. These products can cause physical injuries to the operator and irreversible damage to the machine.
- The machine has hot surfaces which can cause burns. Operate the unit in a safe environment and away from children.
- Do not allow the high pressure hose to come into contact with the muffler guard.
- Do not leave the machine running unattended.
- Learn how to stop the machine and release pressure quickly. Be thoroughly familiar with the controls.
- Stay alert — watch what you are doing.
- Do not operate the product when fatigued or under the influence of alcohol or drugs.
- Do not stand on unstable surfaces. Stand with both feet balanced at all times.
- Avoid tipping the machine on its side.

- The Gun Safety Lock PREVENTS the trigger from accidentally being engaged. This safety feature DOES NOT lock trigger in the on position.
- Do not spray electrical connections, electrical outlets or fixtures.
- Do not touch hot surfaces or allow accessories to contact hot surfaces.
- Do not operate in an enclosed space, exhaust fumes are dangerous.
- Do not operate near utilities with open flames.
- Do not operate pressure washer without the water turned on.
- Do not use hot water.

WATER SUPPLY (Cold Water Only)

- Water hose must be at least 5/8 inch in diameter.
- Flow rate of water supply must not fall below 2.5 GPM (gallons per minute).
- Flow rate can be determined by running the water for one minute into an empty 5-gallon container.
- The water supply temperature must not exceed 104°F/40°C.
- Never use the pressure washer to draw in water contaminated with solvents, e.g. paint thinners, gasoline, oil, etc.
- Always prevent debris from being drawn into the unit by using a clean water source.

We strongly recommend that this high pressure washer not be left running for periods of 5 minutes or longer without the trigger gun being engaged.

- SAVE THESE INSTRUCTIONS -

ASSEMBLY INSTRUCTIONS

Step 1

Attach the handle to the frame of the pressure washer. Align holes, insert bolts, and tighten with knobs.

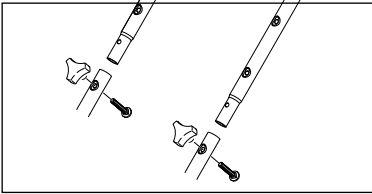

Step 2

Attach the gun/hose storage handle.

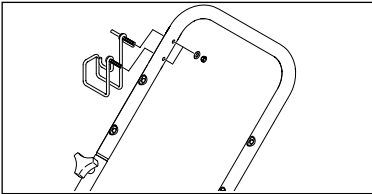

Step 3

Place the quick connect nozzles in the nozzle holder.

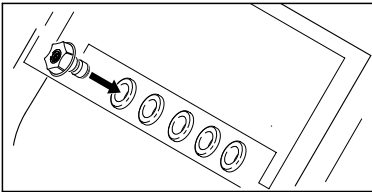

Step 4

Attach the wand to the spray gun.

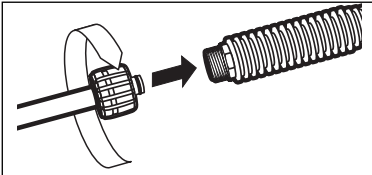

Step 5

Pull the spring-loaded collar of the wand back to insert your choice of quick connect nozzle.

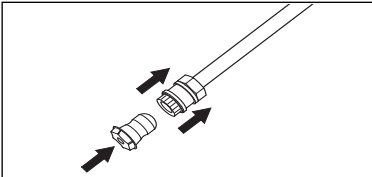

Step 6

Release the collar and push the nozzle until the collar clicks.

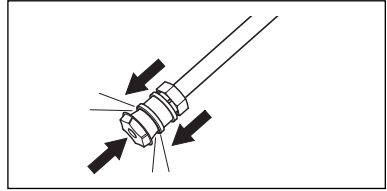

DANGER

High pressure in nozzle area.

Risk of injury caused by improper locked nozzle.

- Make sure you hear a 'click' when inserting the nozzle tip into the wand.
- Pull the nozzle to make sure it is seated properly before operating your unit.

Step 7

Attach the high pressure hose to the spray gun.

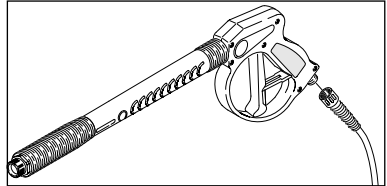

5

Step 8

Prior to initial startup, cut off tip of oil reservoir cap.

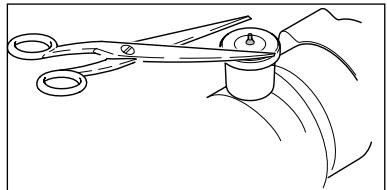

OPERATING INSTRUCTIONS

Important!

Do not run the engine with a high or low oil level as this can cause engine damage.

If you have further questions regarding the engine, please refer to the engine's operating manual included with the unit.

Step 1

Check oil level on engine before starting the unit. Oil level should be level with the bottom of the oil filler neck.

Be sure the machine is level when checking the oil level. (Refer to the engine's operating manual for seasonal grades.)

We recommend that the oil be changed after the first 2 hours of use, then once every 25 hours.

Step 2

Fill gas tank with unleaded gasoline.

Do not use leaded gasoline.

Step 3

6 Connect the high pressure hose to the unit's high pressure outlet.

Step 4

Connect garden hose to unit's water inlet.

Step 5

Connect garden hose to the cold water source and turn water on completely.

Do not use hot water.

Step 6

Trigger the gun to eliminate trapped air, wait for a steady flow of water to emerge from the spray nozzle.

Step 7

Open fuel valve. Set choke lever to the CLOSED position

Starting a Warm Engine:

If the engine has run out of fuel, set choke lever to the CLOSED position after refueling. If the engine has not run out of fuel, leave the choke lever in the OPEN position.

Step 8

Engine with manual throttle:

Slide the throttle lever away from the SLOW position, about 1/3 of the way toward the FAST position.

Engine with fixed throttle:

Move the engine stop switch to the ON position.

Step 9

Pull the starter handle.

If the engine fails to start after 3 pulls, squeeze the trigger gun to release pressure, and repeat step.

For more details see engine manual.

MAINTENANCE INTERVALS FOR PUMP

We recommend that the oil be changed after the first 100 hours of use, then once every 500 hours.

Recommended oil for pump

Use multi-grade 4-stroke motor oil that meets or exceeds the requirement for API service classification SH, SJ, or equivalent.

Use oil SAE-class 15W-40.

Oil Change for pump

Drain the pump oil when the pump is warm. Warm oil drains quickly and completely.

1. Place a suitable container below the pump to catch the used oil.
2. Remove the oil fill cap, the oil drain plug and washer.
3. Allow the used oil to drain completely, then reinstall the drain plug and washer. Tighten the drain plug securely.

Please dispose of used oil in a manner that is compatible with the environment. We suggest you take used oil in a sealed container to your local recycling center. Do not throw it in a trash or pour it on the ground or down a drain.

4. With the pump in a level position, fill in 0.350 liters (11.84 Fl.oz) of recommended oil. Do not overfill.

Notice:

Running the pump with a low oil level can cause pump damage.

5. Reinstall the oil fill cap securely.

USING THE ACCESSORIES

The color-coded quick connect nozzles provide a wide array of spray widths from 0° to 65° and are easily accessible when placed in the convenient rubber nozzle holder, which is provided on the back of the machine.

- **Red nozzle = 0°**
for particularly stubborn accumulation of grime.



- **Yellow nozzle = 15°**
for dirt accumulation over a surface.



- **Green nozzle = 25°**
for dirt accumulation over a large surface.

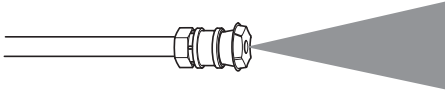

- **White nozzle = 40°**
for dirt accumulation over a large surface.

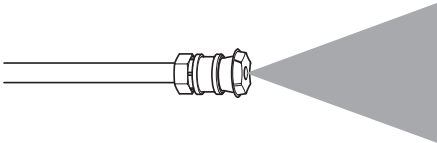

- **Black detergent nozzle = 65°**
for operating with detergent or cleaning with negligible pressure.

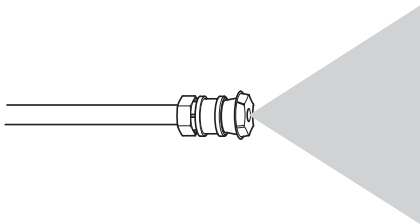

DANGER

High pressure in nozzle area.

Risk of injury caused by improper locked nozzle.

- Make sure you hear a 'click' when inserting the nozzle tip into the wand.
- Pull the nozzle to make sure it is seated properly before operating your unit. (See page 5 step 5 + step 6)

WARNING

TO AVOID SERIOUS INJURY,
NEVER POINT SPRAY NOZZLE
AT YOURSELF, OTHER PERSONS
OR ANIMALS

WORKING WITH DETERGENTS

Detergents can only be applied with the black nozzle.

Step 1

Install the black quick-connect low pressure nozzle for detergent application at low pressure.

Step 2

Adjust the filter end of the detergent tube for light (- / 0.15 gpm), or maximum (+ / 0.20 gpm) detergent coverage.

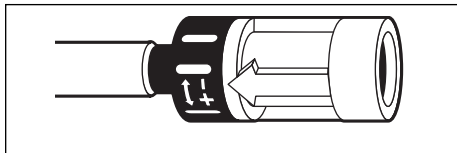

Step 3

Fill a container with Kärcher detergent. Place the filter end of detergent suction tube into the detergent.

8

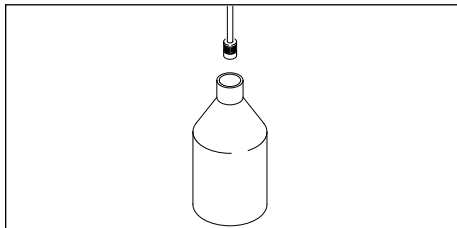

Step 4

With the engine running, pull trigger to operate unit. Liquid detergent is drawn into the unit and mixed with water. Apply detergent to work area. Do not allow detergent to dry on surface.

For best results see Cleaning Tips on pages 10 & 11 for specific information on how to clean different surfaces.

Always Use Kärcher Detergents for Best Results.

Kärcher biodegradable detergents are specially formulated to protect the environment and your pressure washer. Special formula won't clog the suction tube filter and will protect the internal parts of the pressure washer for a longer life. For Kärcher Detergents, check your retailer or call our service center for help.

The following Kärcher detergents are available in USA:

- All Purpose and Vehicle Wash
- Exterior House Cleaner
- Deck & Patio Cleaner
- Heavy Duty Degreaser

The following Kärcher detergents are available in Canada:

- Vehicle Wash
- Pressure Wash
- Deck + Fence Wash
- Degreaser



Caution Never use:

- Bleach, Chlorine products and other corrosive chemicals
- Liquids containing solvents (i.e., paint thinners, gasoline, oils)
- Tri-sodium phosphate products
- Ammonia products
- Acid-based products

These chemicals will harm the unit and will damage the surface being cleaned.

SHUTTING DOWN

Step 1

Remove detergent suction tube from container and insert into 1 gallon of fresh water.

Siphon water at low pressure for one minute.

Step 2

Engine with manual throttle:

- Move the throttle lever to the SLOW position.
- Allow the engine to idle for a few seconds, then move the throttle lever to the STOP position.

Engine with fixed throttle:

Move the engine stop switch to the OFF position.

- Close fuel valve.

For more details see engine manual.

Step 3

Turn off the water supply.

Step 4

Press trigger to release water pressure.

Step 5

Disconnect the garden hose from the water inlet on the unit.

Step 6

Disconnect the high pressure hose from the high pressure outlet.

Step 7

Engage the gun safety lock.

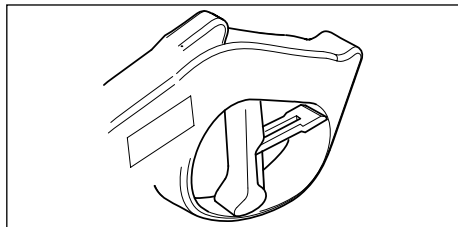

TAKING A BREAK

... FIVE MINUTES OR MORE

Step 1

Engine with manual throttle:

Move the throttle lever to the SLOW position to shut down engine.

Allow the engine to idle for a few seconds, then move the throttle lever to the STOP position.

Engine with fixed throttle:

Move the engine stop switch to the OFF position.

For more details see engine manual.

Step 2

Press trigger to release water pressure.

Step 3

Engage gun safety lock.

WINTERIZING AND LONG-TERM STORAGE

1. Disconnect all water connections.
2. Turn on the machine for a few seconds, until the water which had remained in the pump exits. Turn off immediately.
3. Drain the gas and oil from the engine.
4. Do not allow high pressure hose to become kinked.
5. Store the machine and accessories in a room which does not reach freezing temperatures.

Caution: Failure to follow the above directions will result in damage to the pump assembly and accessories.

Only for USA:

Kärcher also recommends the regular practice of using a pump protector like 'Kärcher Pump Protector' to help during storage in the winter months.

CLEANING TIPS

Deck Cleaning (with or without detergent)

Pre-rinse deck and surrounding area with fresh water. If using Kärcher Deck & Patio Cleaner, (*Canada: Deck + Fence Wash*) place detergent suction tube directly into cleaning solution and apply to surface at low pressure. For best results, limit your work area to smaller sections of approximately 25 square feet. Allow detergent to remain on surface 1-3 minutes. Do not allow detergent to dry on surface. Rinse at high pressure in a long sweeping motion keeping the spray nozzle approximately 3-6 inches from the cleaning surface. Always clean from top to bottom and from left to right. When moving on to a new section of the cleaning surface, be sure to overlap the previous section to eliminate stop marks and ensure a more even cleaning result.

Caution: *Do not use Dirtblaster® spray nozzle on wood surface as it may cause damage.*

10 House Siding (with or without detergent)

Pre-rinse cleaning surface with fresh water. If using Kärcher Exterior House Cleaner (*Canada: Pressure Wash*), place detergent suction tube directly into cleaning solution and apply to surface at low pressure (for best results, limit your work area to sections of approximately 6 feet and always apply detergent from bottom to top). Allow detergent to remain on surface 1-3 minutes. Do not allow detergent to dry on surface, if surface appears to be drying, simply wet down surface with fresh water. Rinse at high pressure from top to bottom in an even sweeping motion keeping the spray nozzle approximately 6 inches from the cleaning surface.

Caution: *Do not use Dirtblaster® Spray Nozzle on siding as it may cause damage.*

Cement Patios, Brick and Stone (with or without detergent)

Pre-rinse cleaning surface with fresh water. If using Kärcher All Purpose and Vehicle Wash (*Canada: Pressure Wash or Degreaser*), place detergent suction tube directly into cleaning solution and apply to surface at low pressure. For best results, limit your work area to smaller sections of approximately 25 square feet. Allow detergent to remain on surface 1-3 minutes. Do not allow detergent to dry on surface. Rinse at high pressure in a sweeping motion keeping the spray nozzle approximately 3-6 inches from the cleaning surface. Always clean from top to bottom and from left to right. For removing extremely stubborn stains, use Kärcher Dirtblaster® Spray Nozzle.

Cars, Boats & Motorcycles (with or without detergent)

Pre-rinse vehicle with fresh water. If using Kärcher All Purpose and Vehicle Wash, (*Canada: Pressure wash or vehicle wash*) place detergent suction tube directly into cleaning solution and apply to surface at low pressure. For best results, clean one side of vehicle at a time and always apply detergent from bottom to top, do not allow detergent to dry on surface. Rinse at high pressure in a sweeping motion keeping the spray nozzle approximately 6-8 inches from the cleaning surface (distance should increase when rinsing pin-striping or other sensitive surfaces). Always clean from top to bottom and from left to right. For best results, wipe surface dry with a chamois or soft dry cloth.

Caution: *Do not use Dirtblaster® Spray Nozzle on vehicles as it may cause damage.*

Barbecue Grills, Outdoor Power Equipment & Gardening Tools (with or without detergent)

Pre-rinse cleaning surface with fresh water. If using Kärcher All Purpose and Vehicle Wash or Heavy Duty Degreaser (*Canada: Pressure Wash or Degreaser*), place detergent suction tube directly into cleaning solution and apply detergent at low pressure. Allow detergent to remain on surface 1-3 minutes. Do not allow detergent to dry on surface. Rinse at high pressure keeping the spray nozzle approximately 3-6 inches from the cleaning surface. For removing extremely stubborn dirt, it may be necessary to move the spray nozzle even closer to the surface for greater dirt cutting action. To remove caked on mud from garbage cans, lawn mower blades, wheel barrels or other non-sensitive metal surfaces, you may want to use the Kärcher Dirtblaster® Spray Nozzle.

Caution: *Do not use Dirtblaster® Spray Nozzle on cloth, plastic or other sensitive surfaces as it may cause damage.*

Patio & Lawn Furniture (with or without detergent)

Pre-rinse furniture and surrounding area with fresh water. If using Kärcher All Purpose and Vehicle Wash (*Canada: Pressure Wash*), place detergent suction tube directly into cleaning solution and apply to surface at low pressure. Allow Kärcher detergent to remain on surface 1-3 minutes. Do not allow detergent to dry on surface. Rinse at high pressure in a sweeping motion keeping the spray nozzle approximately 3-6 inches from the cleaning surface. For best results, clean from top to bottom and from left to right.

Caution: *Do not use Dirtblaster® Spray Nozzle on patio or lawn furniture as it may cause damage.*

Recommendations

- Before cleaning any surface an inconspicuous area should be cleaned to test spray pattern and distance for maximum cleaning results.
- If painted surfaces are peeling or chipping, use extreme caution as pressure washer may remove the loose paint from the surface.
- When using on surfaces which might come in contact with food, flush surfaces with plenty of drinking water.

OPTIONAL CLEANING ACCESSORIES

Optional cleaning accessories are available to further enhance your cleaning capabilities.

- Dirtblaster® spray nozzle
- Extension Hose
- Hose Reel

TROUBLESHOOTING

Please remove the spark plug cable to prevent accidental ignition of the engine before making any repair.

Engine will not start.

- **No gasoline.**
 - Fill gas tank.
- **Choke is not in correct position.**
 - Slide choke lever out to closed position.
- **Engine throttle is not in correct position.**
 - Slide the throttle lever up about 1/3 of the way toward the fast position.
- **Pressure built up in the high pressure washer.**
 - Squeeze the trigger to release the pressure.

For additional engine problems refer to the engine owners manual.

12

Unit does not reach high pressure.

- **Diameter of garden hose is too small.**
 - Replace with a 3/4 inch garden hose.
- **Water supply is restricted.**
 - Check garden hose for kinks, leaks and blockage.
- **Not enough inlet water supply.**
 - Open water source full force.
- **Water inlet filter is clogged.**
 - Remove filter and rinse out in warm water.
- **Black detergent nozzle is attached.**
 - Remove black detergent nozzle and attach a high pressure nozzle.

Output pressure varies high and low.

- **Not enough inlet water supply.**
 - Turn water on full force. Check garden hose for kinks, leaks or blockage.
- **Pump is sucking air.**
 - Check that hoses and fittings are air tight. Turn off machine and purge pump by squeezing trigger gun until a steady flow of water emerges through the nozzle.
- **Water inlet filter is clogged.**
 - Remove filter and rinse out in warm water.
- **Spray nozzle is obstructed.**
 - Blow out or remove debris with a fine needle.
- **Calcified gun, hose or spray wand.**
 - Run distilled vinegar through detergent suction tube.

No detergent.

- **Detergent suction tube not properly connected to the machine.**
 - Check connection.
- **Detergent is too thick.**
 - Dilute detergent. For best results, use Kärcher detergent.
- **Detergent filter valve is at lowest setting.**
 - Set detergent filter valve to a higher setting.
- **Filter on detergent suction tube is clogged.**
 - Run warm water through filter to remove debris.
- **Damaged or clogged detergent suction tube.**
 - Remove obstruction or replace detergent suction tube.
- **A high pressure nozzle is attached.**
 - Replace with black detergent nozzle.
- **Spray nozzle is obstructed.**
 - Blow out or remove debris with fine needle.

Garden hose connection leaks.

- **Loose fittings.**
 - Tighten fittings.
- **Missing/worn rubber washer.**
 - Insert new washer.

Spray wand leaks.

- **Spray wand not properly attached.**
 - Attach the wand to the spray gun.
Turn the wand collar clockwise onto the gun threads until tight.
- **Broken o-ring.**
 - Call Kärcher customer service hotline and order an o-ring.

Pump is noisy.

- **Pump is sucking air.**
 - Check that hoses and fittings are air tight. Turn off machine and purge pump by squeezing trigger gun until a steady flow of water emerges through the nozzle.

Water leaks from pump.

- **Loose fittings.**
 - Check that all fittings are tight.
- **Water seals are damaged or worn.**
 - Call customer service.
- **Thermal protection device is activated.**
 - Thermal protection device will auto reset. Do not run pump for more than 5 minutes without spraying.

Oil Drip.

- **Oil seals are damaged or worn.**
Call customer service.

If you encounter any additional difficulties not listed, please call our customer support for help.

Kärcher Commercial USA

To locate a dealer, call:

1-888-805-9852

or visit our website:

www.karchercommercial.us