

CV 38/2

CV 48/2

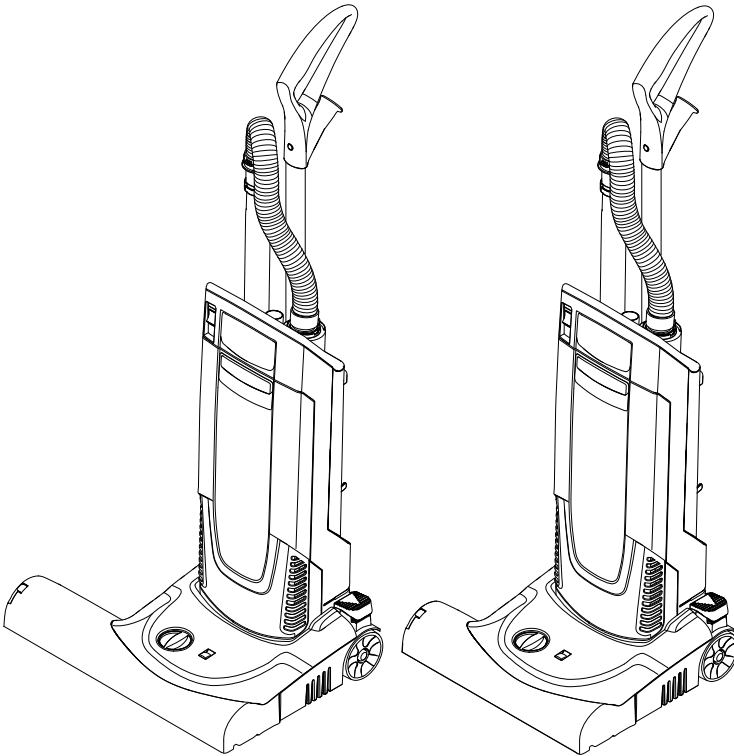

English	3 / 20
Français	6 / 22
Español	9 / 24



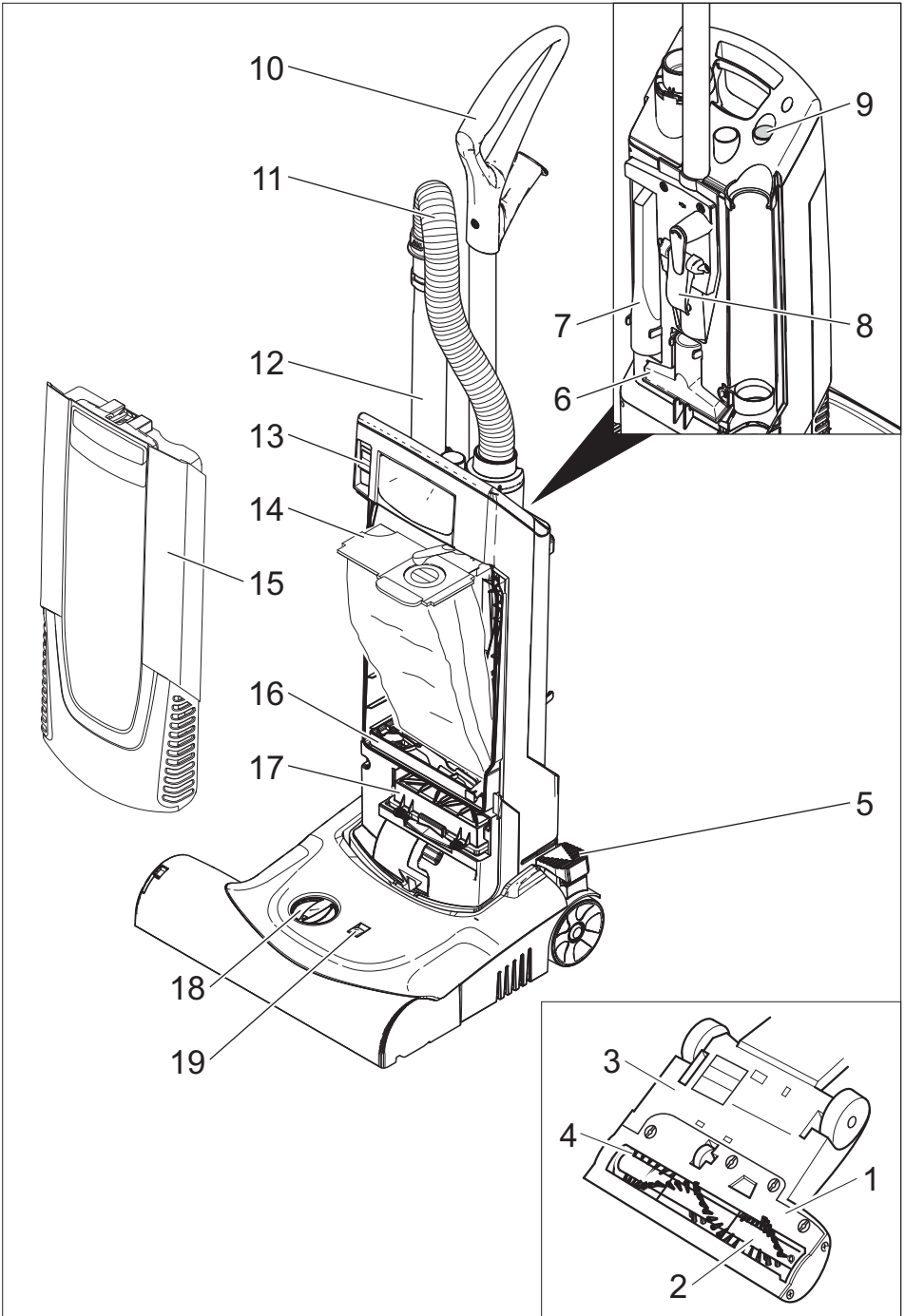

IMPORTANT SAFETY INSTRUCTIONS

READ ALL INSTRUCTIONS BEFORE USING THIS MACHINE.

- Inform your dealer immediately if there is any transport damage.
- Completely remove the accessories from the carton.
- The suction unit is not suitable for sucking up hazardous dusts as asbestos. Please consult your Kärcher branch or your Kärcher dealer with regard to such applications.
- Only operate the suction unit from a suitable socket outlet with earthing contact. Refer to the Technical data for the necessary main fuse.
- Connect to a properly grounded outlet only - see Grounding instructions.

When using an electrical appliance, basic precautions should always be followed, including the following: This vacuum is intended for commercial use.

- 1 DISCONNECT VACUUM CLEANER FROM POWER CIRCUIT before removing the cover, performing maintenance work, and when not in use.
- 2 DO NOT LEAVE appliance when plugged in.
- 3 ALWAYS CHECK THE POWER SUPPLY CORD for damage or signs of any aging before each use.
- 4 DO NOT PULL OR CARRY VACUUM CLEANER BY CORD. Do not close door on cord or pull cord around sharp edges.
- 5 KEEP CORD AWAY FROM HEAT AND OIL. Do not leave cord lying around after job is complete. It can become a tripping hazard.
- 6 DO NOT RUN VACUUM OVER CORD.
- 7 TURN SWITCH TO OFF before unplugging power supply cord.
- 8 DO NOT UNPLUG BY PULLING CORD. To unplug, grasp plug, not cord.
- 9 DO NOT GRASP PLUG WITH WET HANDS.
- 10 A DAMAGED CORD OR PLUG should only be replaced by an authorized service center representative. DO NOT ATTEMPT TO REPAIR POWER CORD.
- 11 TO AVOID SHOCK, do not expose to rain. Store indoors.
- 12 USE ONLY AS RECOMMENDED BY THIS MANUAL. Use only with recommended attachments.
- 13 KEEP HAIR, CLOTHING, LOOSE JEWELRY, FINGERS and all parts of the body away from openings and moving parts.
- 14 DO NOT BLOCK OR OBSTRUCT OPENINGS. Keep openings free of lint, hair, dust, and anything that restricts air flow.
- 15 DO NOT PICK UP ANYTHING THAT IS BURNING, smoldering, or smoking such as matches, cigarettes, or hot ashes.
- 16 DO NOT USE TO VACUUM COMBUSTIBLE EXPLOSIVE MATERIALS, such as coal, grain, and other finely divided combustible material.
- 17 DO NOT USE TO VACUUM COMBUSTIBLE, hazardous, toxic, or carcinogenic materials, including gasoline, diesel fuel, acetone, paint thinner, heating oils, undiluted acids and solvents, pesticide, and asbestos.
- 18 USE RECOMMENDED FILTERS when vacuuming drywall materials.
- 19 DO NOT USE WITHOUT FILTER and/or dust bag in proper place.
- 20 CONNECT VACUUM CLEANER WITH PROPERLY GROUNDED OUTLET ONLY. See grounding instructions.
- 21 DO NOT ALLOW VACUUM CLEANER TO BE USED AS A TOY. Keep children away from Vacuum Cleaner.
- 22 DO NOT LEAVE UNATTENDED while Vacuum Cleaner is running.

- 23 DO NOT USE IF CORD, PLUG, FILTER, OR VACUUM CLEANER IS IN POOR CONDITION. If the Vacuum Cleaner has been dropped, damaged, exposed to weather, or dropped into water; have it checked by an authorized service .
- 24 ALWAYS USE EYE PROTECTION when operating Vacuum Cleaner.
- 25 USE EXTRA CAUTION when operating on stairs.
- 26 STAY ALERT! Do not use Vacuum Cleaner when you are tired or under the influence of drugs, alcohol or medication.

SAVE THESE INSTRUCTIONS

This vacuum is intended for commercial use.

SAFETY INSTRUCTIONS

GROUNDING INSTRUCTIONS

This appliance must be grounded. If it should malfunction or break down, grounding provides a path of least resistance for electric current to reduce the risk of electric shock.

This appliance is equipped with a cord having an equipment grounding conductor and ground plug.

The plug must be inserted into an appropriate outlet that is properly installed and grounded in accordance with all local codes and ordinances.

WARNING:

Improper connection of the equipment-grounding conductor can result in a risk of electric shock.

Check with a qualified electrician or service person if you are in doubt as to whether the outlet is properly grounded.

Do not modify the plug provided with the appliance.

If it will not fit the outlet, have a proper outlet installed by a qualified electrician.

This appliance is for use on a nominal 120-volt circuit, and has a grounded plug that looks like the plug illustrated in Fig.A.

A temporary adapter that looks like the adapter illustrated in Fig.B, may be used to connect this plug to a two-pole receptacle as shown in Fig.B, if a properly grounded outlet is not available.

The temporary adapter should be used only until a properly grounded outlet (Fig.A) is installed by a qualified electrician.

The green colored rigid ear, lug, or the like extending from the adapter must be connected to a permanent ground such as a properly grounded outlet box cover.

Whenever the adapter is used, it must be held in place by a metal screw.

IN ALL CASES, MAKE SURE THE RECEPTACLE IN QUESTION IS PROPERLY GROUNDED.

NEVER REMOVE GROUNDING PRONG FROM POWER PLUG.

EXTENSION CORDS

Use only three-wire extension cords that have three-prong grounding-type plugs and three-pole receptacle that accepts the appliance's plug. Replace damaged or worn cord immediately.

DO NOT ATTEMPT TO REPAIR POWER CORD.

Figure A

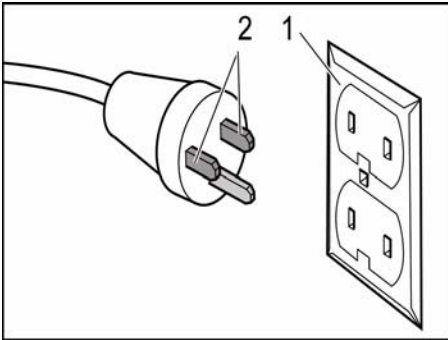

- 1 Grounded outlet box
 - 2 Current carrying prongs
- Grounding prong is longest of the 3 prongs

Figure B

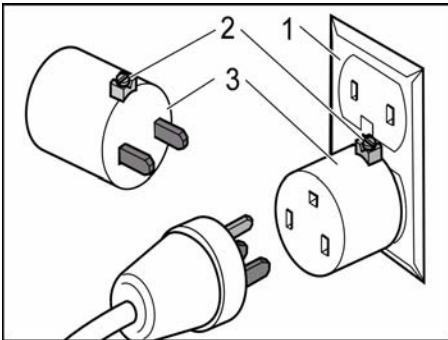

- 1 Grounded outlet box
- 2 Grounding means
- 3 Adapter

Note:

In Canada, the use of a temporary adapter is not permitted by the Canadian Electrical Code.

Servicing of double-insulated appliances

In a double-insulated appliance, two systems of insulation are provided instead of grounding. No grounding means is provided on a double-insulated appliance, nor should a means for grounding be added to the appliance. Servicing a double-insulated appliance requires extreme care and knowledge of the system, and should be done only by qualified service personnel. Replacement parts for a double-insulated appliance must be identical to the parts they replace.

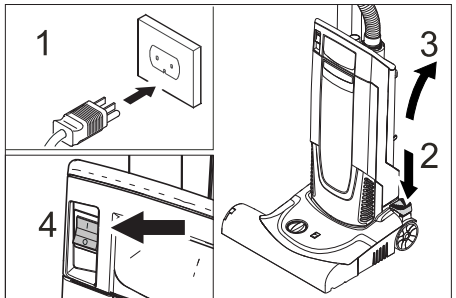
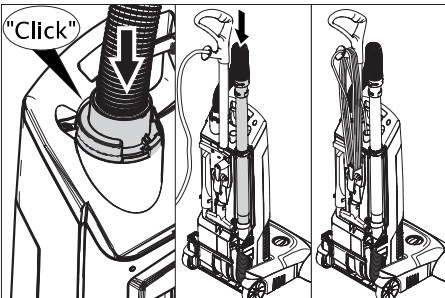
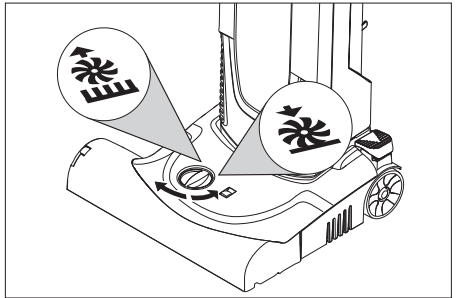
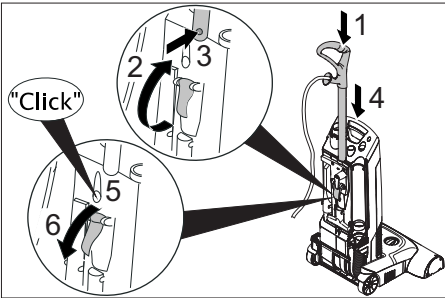
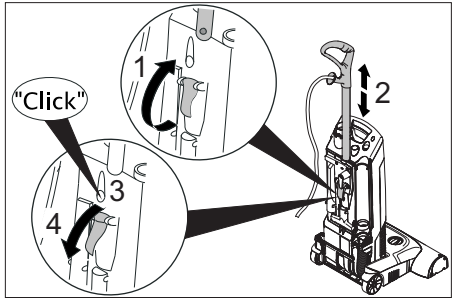
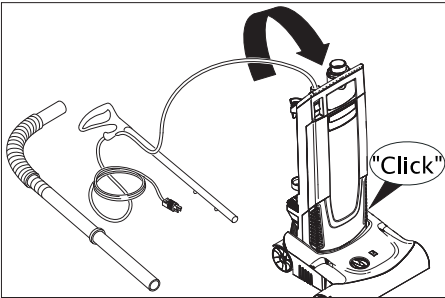
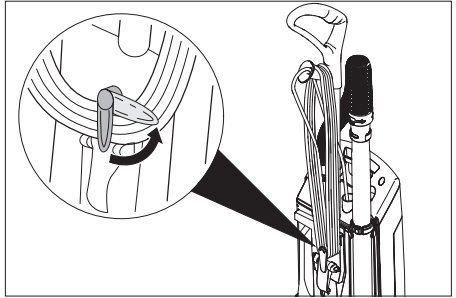
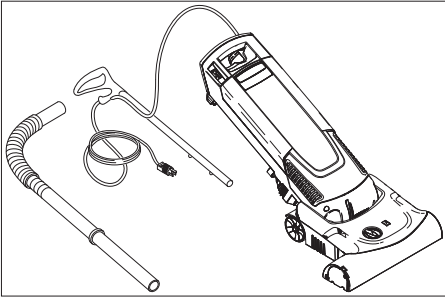

EN

⚠ Warning

When you vacuum with the suction hose, the device must lock into place in home position in order to allow the brush motor to switch off.

FR

⚠ Avertissement

L'appareil doit s'enclencher dans la position de repose lors de l'aspiration avec le flexible d'aspiration afin que le moteur de la brosse se mette hors service.

ES

⚠ Advertencia

Para absorber con el tubo de absorción se debe encajar el aparato en posición de descanso para que el motor del cepillo se desconecte.

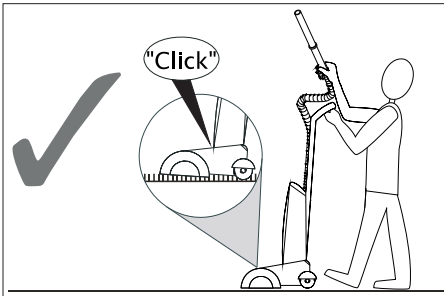
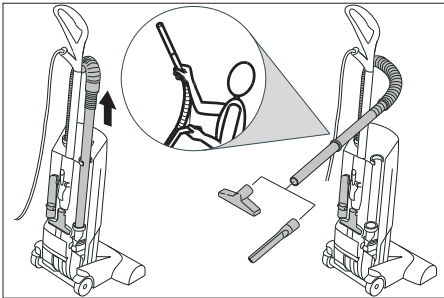

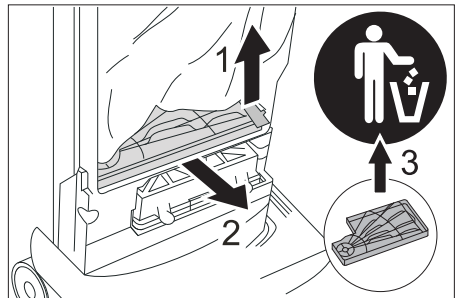
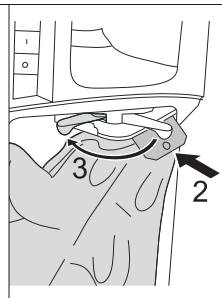
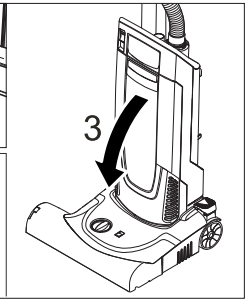
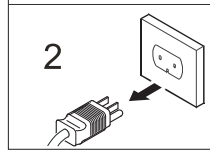
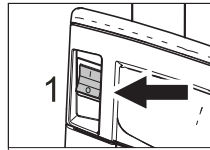
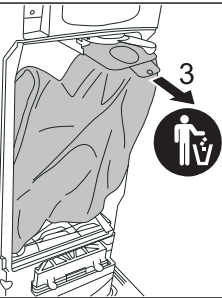
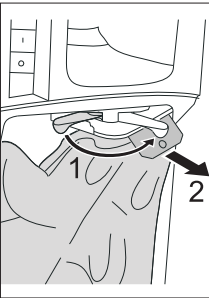
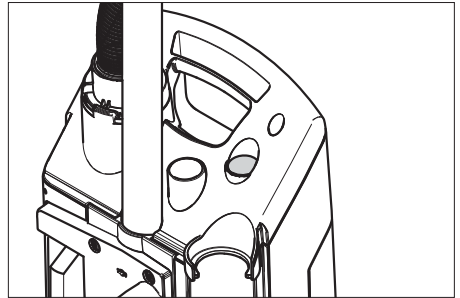
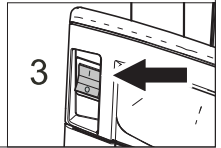
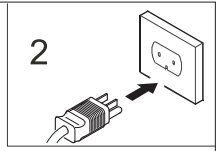
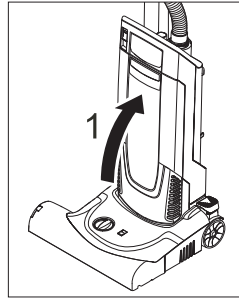
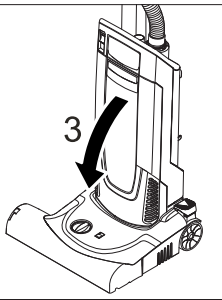
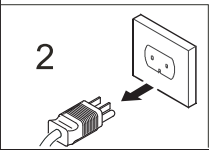
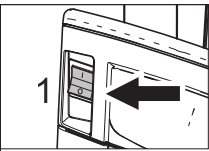
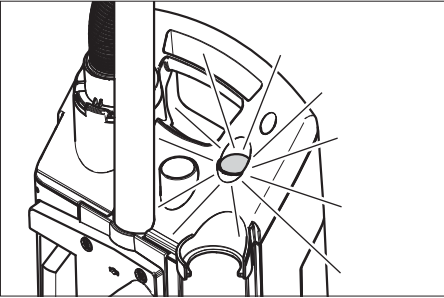

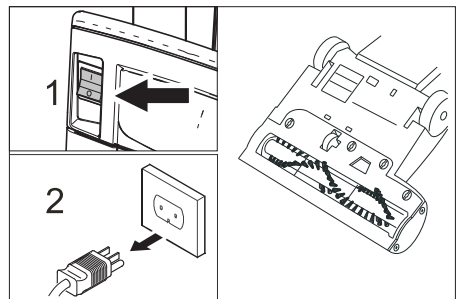
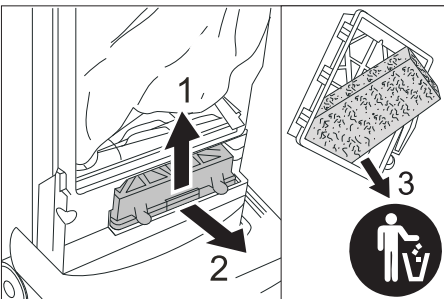
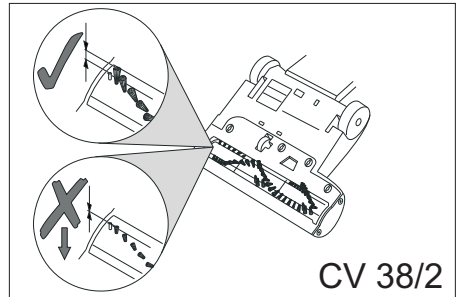
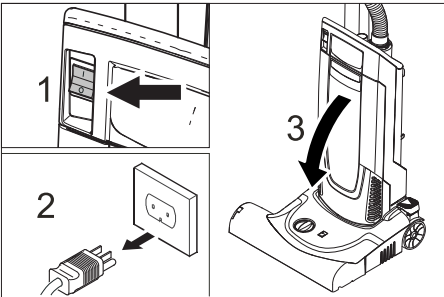
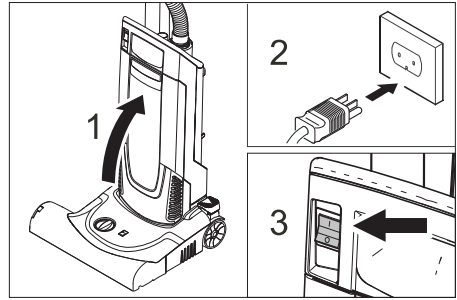
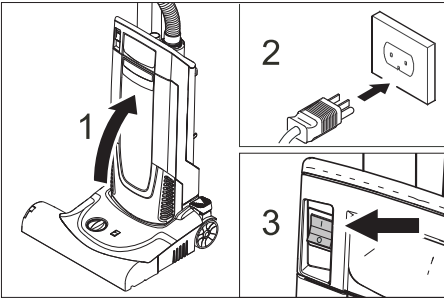
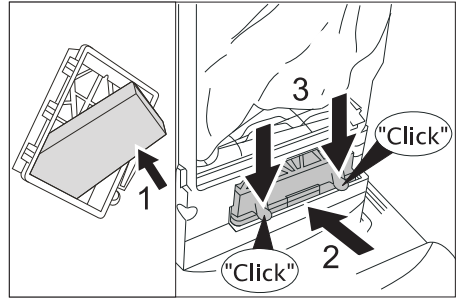
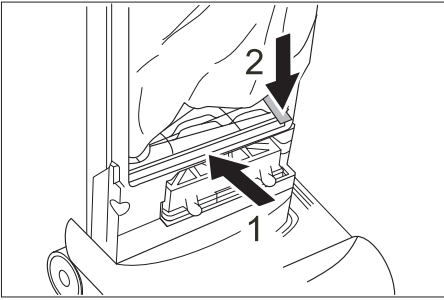

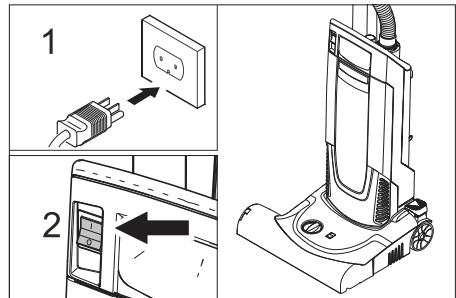
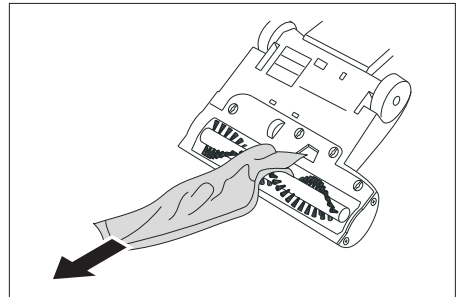
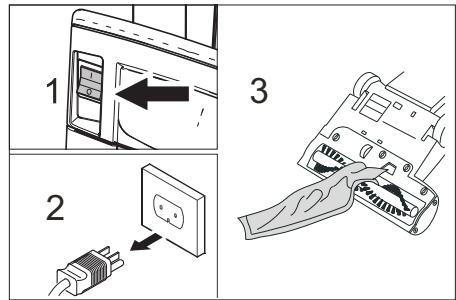
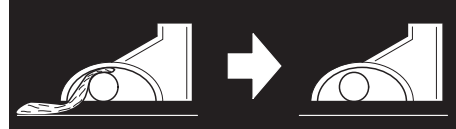
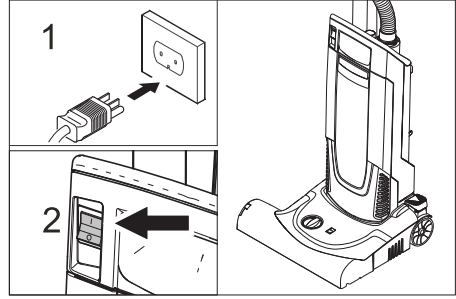
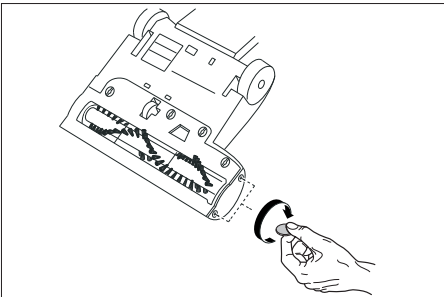
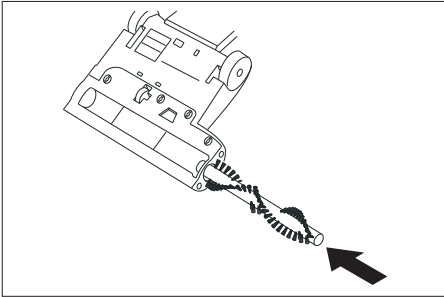
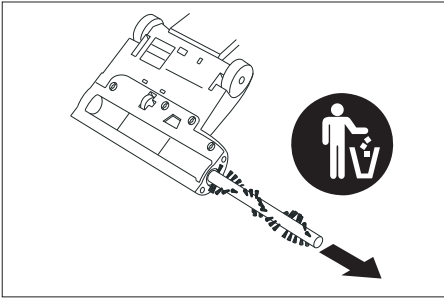
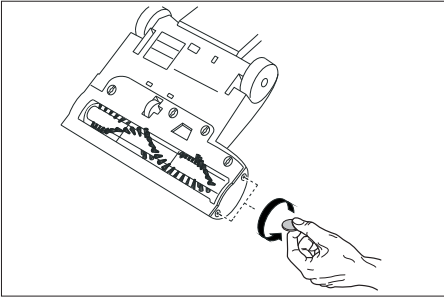

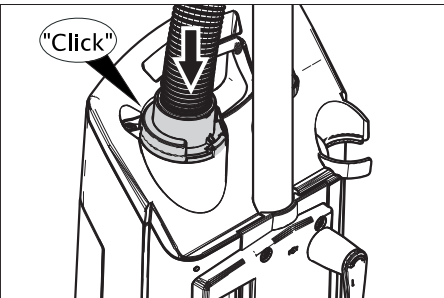
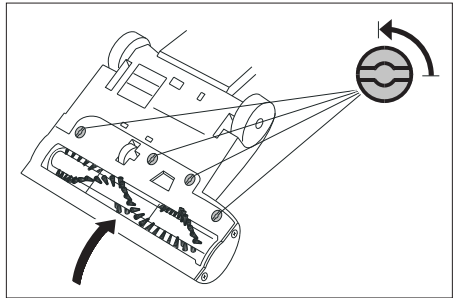
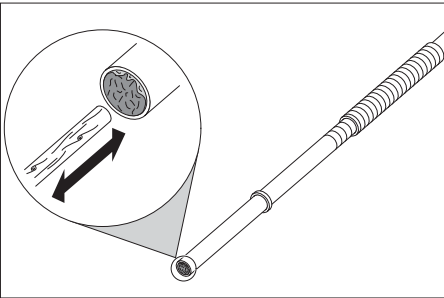
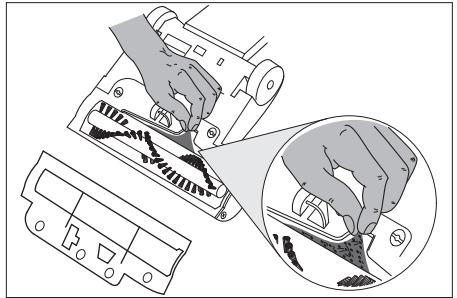
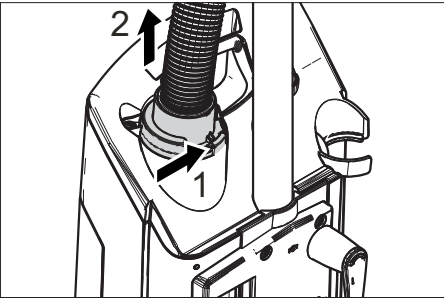
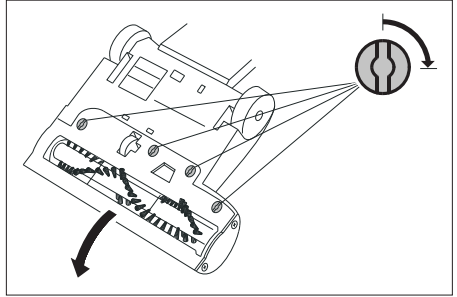
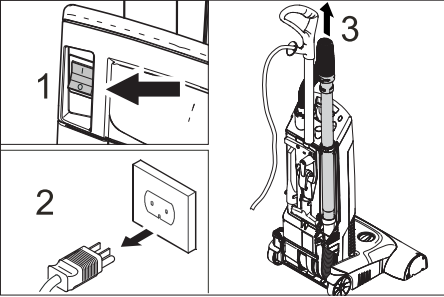
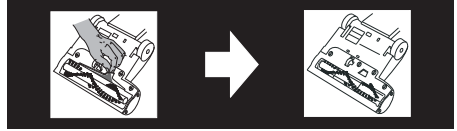
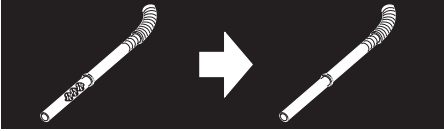

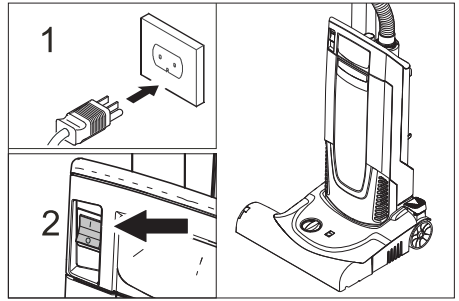
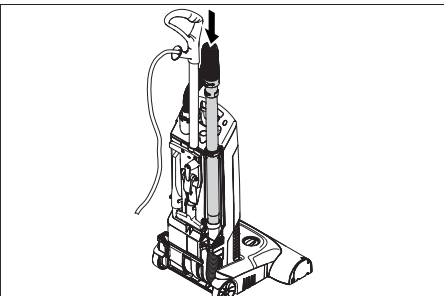
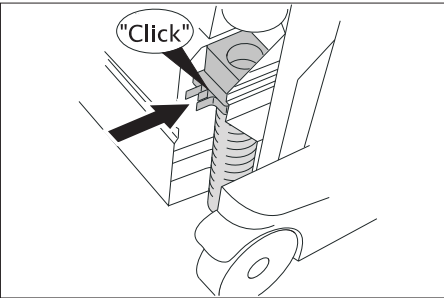
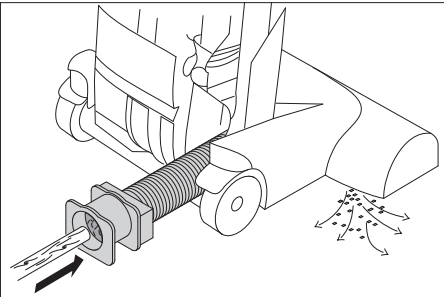
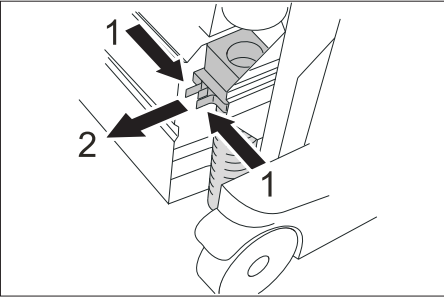
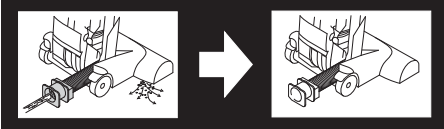



Please read and comply with these original operating instructions prior to the initial operation of your appliance and store them for later use or subsequent owners.

- Before first start-up it is definitely necessary to read the safety indications Nr. 5.956-249!
- The non-compliance of the operating and safety instructions may lead to damages of the appliance and to dangers for the operator and other persons.
- In case of transport damage inform vendor immediately
- When unpacking the product, make sure that no accessories are missing and that none of the package contents have been damaged.

Environmental protection

	The packaging material can be recycled. Please do not throw the packaging material into household waste; please send it for recycling.
	Old appliances contain valuable materials that can be recycled; these should be sent for recycling. Batteries, oil, and similar substances must not enter the environment. Please dispose of your old appliances using appropriate collection systems.

Notes about the ingredients (REACH)

You will find current information about the ingredients at:

<http://www.karcher.de/de/unternehmen/umweltschutz/REACH.htm>

Proper use

- The appliance is meant for dry cleaning of floors and walls.
- This appliance is suited for the commercial use, e.g. in hotels, schools, hospi-

tals, factories, shops, offices, and rental companies.

Device elements

Illustration on Page 2

- 1 Brush cover
- 2 Brush
- 3 Brush head
- 4 Indicator bundle (CV 38/2 only)
- 5 Unlocking brushg head
- 6 Upholstery nozzle
- 7 Crevice nozzle
- 8 Handle adjustment
- 9 Indicator lamp on the filter housing (red)
- 10 Handle
- 11 Suction hose
- 12 Suction pipe
- 13 Power switch
- 14 Filter bag
- 15 Filter cover
- 16 Motor filter
- 17 Blower filter
- 18 Pile height adjustment knob
- 19 Indicator lamp - Electronic brush control (orange)

Operation

Electronic brush control

The electronic brush control continuously monitors the working of the brush.

- **No light**
Brush is working properly.
- **Orange light is glowing**
Set the adjustment knob for pile height to the lower pile height.
- **Orange light also glows at lowest level**
Replace brush.

Troubleshooting

Motor does not run

- No electrical voltage.

- Check cables, plugs, fuse, and socket.
- Thermostat switched off the motor because of overheating
- Pull mains plug, replace blocked filters, or remove blockage from the suction hose.

The unit is operational again after it has cooled down.

Unsatisfying suction result

- Check the brush for blocking objects.
- Remove obstructions from brush head, suction pipe and suction hose.
- Replace the filter bag.
- Replace blower filter and motor protection filter.
- Check the pile height adjustment knob for correct adjustment.
- CV 38/2 only: The brush must be replaced when it is worn out. The degree of wear is shown by a comparison with the indicator bundle of a different colour. The brush must be replaced when the black bristles are at the same level as the red ones.

The red indicator lamp on the filter housing is ON

- Remove obstructions from brush head, suction pipe and suction hose.
- Replace the filter bag.

The orange indicator lamp - Electronic brush control is ON

- Set the adjustment knob for pile height to the lower pile height.

The orange indicator lamp - Electronic brush control is also ON at lowest level

- Replace brush.

Warranty

The warranty terms published by the relevant sales company are applicable in each country. We will repair potential failures of your appliance within the warranty period

free of charge, provided that such failure is caused by faulty material or defects in manufacturing. In the event of a warranty claim please contact your dealer or the nearest authorized Customer Service centre. Please submit the proof of purchase.

Accessories and Spare Parts

- Only use accessories and spare parts which have been approved by the manufacturer. The exclusive use of original accessories and original spare parts ensures that the appliance can be operated safely and troublefree.
- At the end of the operating instructions you will find a selected list of spare parts that are often required.
- For additional information about spare parts, please go to the Service section at www.kaercher.com.



120 V / 1~ / 60 Hz

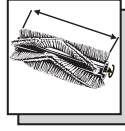

CV 38/2: 13.0 in (335 mm)
CV 48/2: 17.0 in (430 mm)



12 m (4.649-026.0)
SJT 3x18 AWG

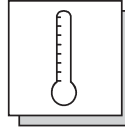

max. 104 °F (+40 °C)
Umgebungstemperatur,
Ambient temperature,
Température ambiante



67 dB(A)

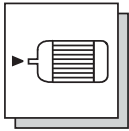

I max: 9 A

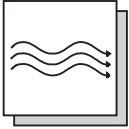

max. 100 CFM (47 l/s)

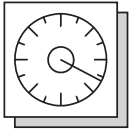

max. 2480 mm (24.3 kPa)

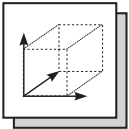

CV 38/2: 48.0 in x 15.5 in x
14.0 in (1215 mm x
390 mm x 350 mm)
CV 48/2: 48.0 in x 19.0 in x
14.0 in (1215 mm x
485 mm x 350 mm)



CV 38/2: 21.8 lbs (9.9 kg)
CV 48/2: 22.9 lbs (10.4 kg)

CV 38/2

CV 38/2

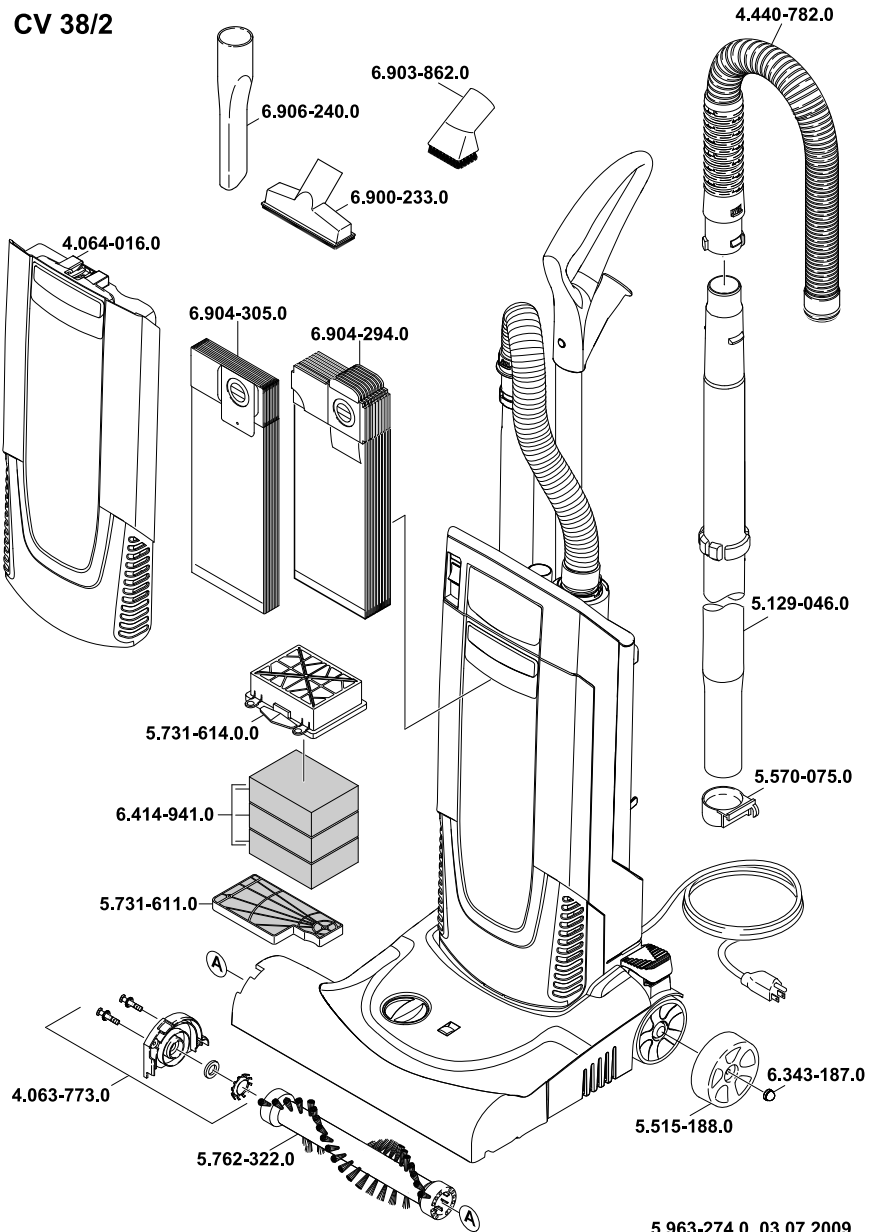

5.963-274.0 03.07.2009